



RELATIVE HUMIDITY MODULE

HM 1500

Based on the rugged HS1101 capacitive humidity sensor, HM1500 is a dedicated humidity transducer designed for OEM applications where a reliable and accurate measurement is needed. Direct interface with a micro-controller is made possible with the module's linear voltage output.

MAIN FEATURES

- Small size
- Not affected by water immersion
- Full interchangeability
- High reliability and long term stability
- Typical 1 to 4 Volt DC output for 0 to 100 % RH at 5 V DC supply
- Calibrated within +/- 2 % RH @ 55 % RH
- Very low temperature dependence
- Ratiometric to voltage supply within the specified range
- Suitable for 3 to 7 Volts supply voltage



HUMIDITY SENSOR SPECIFIC FEATURES

- Instantaneous de-saturation after long periods in saturation phase.
- Patented solid polymer structure.
- High resistance to chemicals.
- Fast response time.

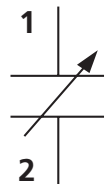

MAXIMUM RATINGS

Ratings	Symbol	Value	Unit
Storage Temperature	T _{stg}	-30 to 70	°C
Supply Voltage (Peak)	V _s	7	Vdc
Humidity Operating Range	RH	0 to 100	% RH
Temperature Operating Range	T _a	-30 to 60	°C

Peak conditions : less than 10% of the operational time.

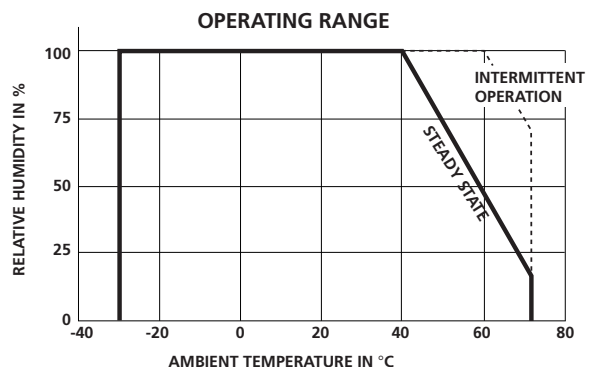

CHARACTERISTICS

(T_a = 23°C, V_s = 5Vdc, R_L > 1MΩ otherwise stated)

Characteristics	Symbol	Min.	Typ.	Max.	Unit.
Humidity measuring range	RH	1		99	% RH
Relative Humidity accuracy (10 to 95 % RH)	RH		+/- 3	+/- 5	% RH
Voltage supply	V _s	4.75	5.00	5.25	V
Nominal output @ RH = 55 %	V _{out}	2.42	2.48	2.54	V
Current consumption	I _c		0.4	0.8	mA
Temperature coefficient (10 to 50 °C)	T _{cc}		+ 0.1		% RH/°C
Averaged Sensitivity from 33% to 75% RH	ΔmV /% RH		+ 25		mV /% RH
Sink current capability (R _L = 15 kΩ)	I _s			300	μA
Recovery time after 150 hours of condensation	t		10		s
Humidity Hysteresis			+/-1.5		% RH
Long term stability			0.5		% RH/yr
Response time (33 to 76 % RH, static, @ 63 %)	τ		10		s
Output impedance	Z		70		Ω

MEASUREMENT CONDITIONS

- HM1500 is specified for accurate measurements within 10 to 95% RH.
- Excursion out of this range (< 10% or > 95% RH, including condensation) does not affect the reliability of HM1500 characteristics.
- Dedicated HM15XX Product are available for extreme RH conditions (as HM1520 for low dewpoints) Consult HUMIREL for further information.

HM 1500 Typical Measuring Ranges in Humidity

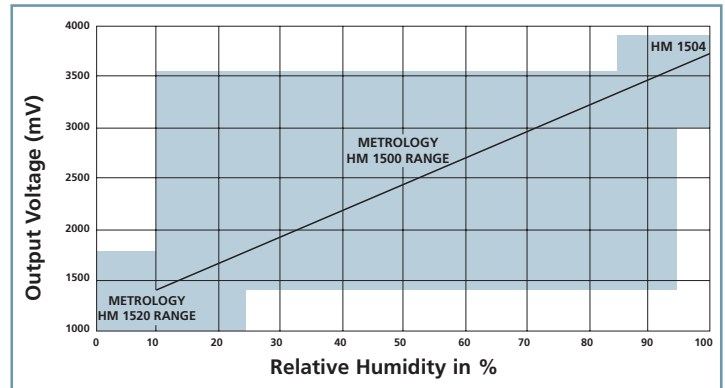

HM1500 MODELLED LINEAR VOLTAGE OUTPUT ($V_s = 5V$)

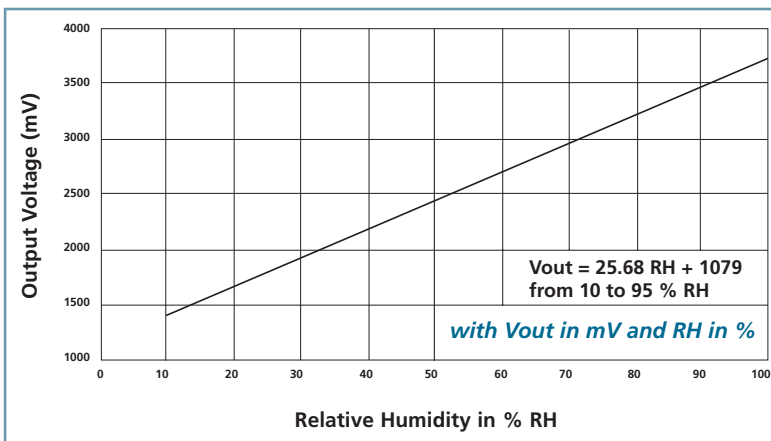

REFERENCE OUTPUT VALUES

RH (%)	$V_{out}(mV)$	RH (%)	$V_{out}(mV)$
10	1325	55	2480
15	1465	60	2605
20	1600	65	2730
25	1735	70	2860
30	1860	75	2990
35	1990	80	3125
40	2110	85	3260
45	2235	90	3405
50	2360	95	3555

Reversed Polynomial Equation

$$V_{out} = 9E^{-4}RH^3 - 1.3E^{-1}RH^2 + 30.815RH + 1030$$

ERROR BUDGET AT 23°C

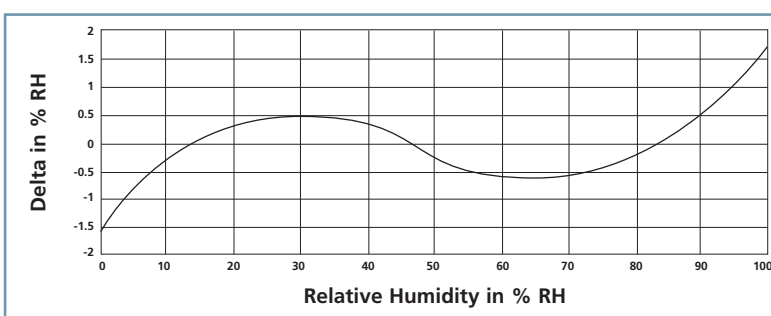
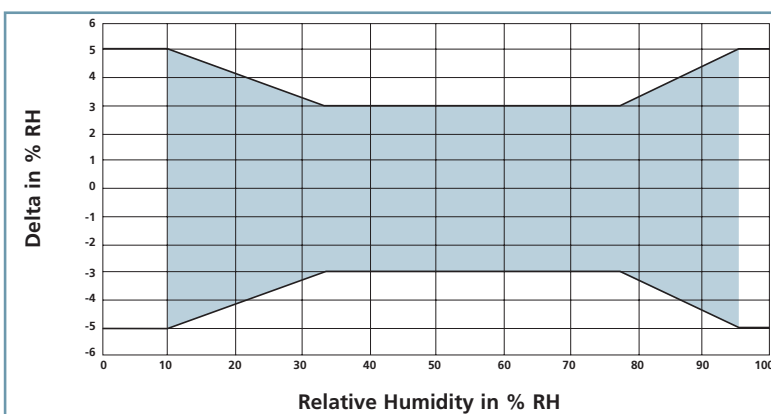

HM1500 ERROR LIMITS

Temperature coefficient compensation

$$RH_{Cor}\% = RH\%_{Read} * (1 - (Ta - 23) * 2.4E^{-3})$$

Non linearity and temperature compensation

$$RH\% = \frac{-1.919E^{-9}V_{out}^3 + 1.335E^{-5}V_{out} + 9.607E^{-3}V_{out} - 21.75}{1 + (Ta - 23) * 2.4E^{-3}}$$

All equations V_{out} in mV, RH in %, T_a in °C.

LINEARITY ERROR OF HM1500 MODULE

HUMIDITY MEASUREMENT USING HM1500

Typical HM 1500 relative Humidity measurement

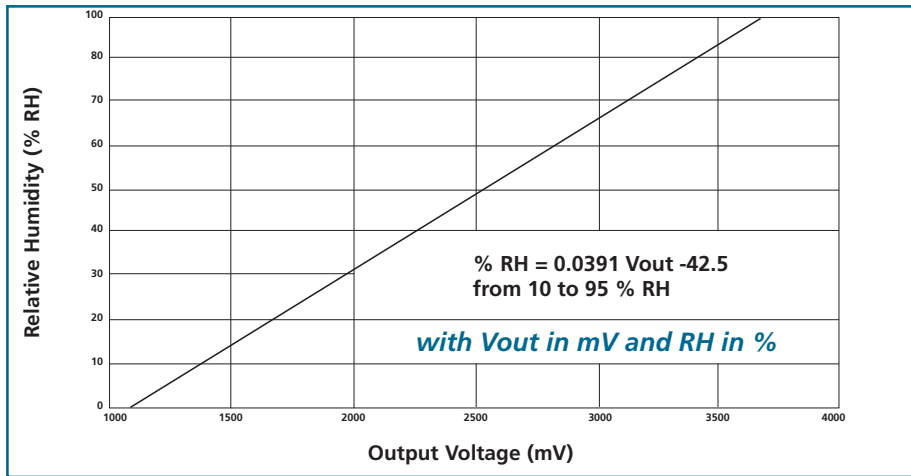

Internal block diagram of HM1500

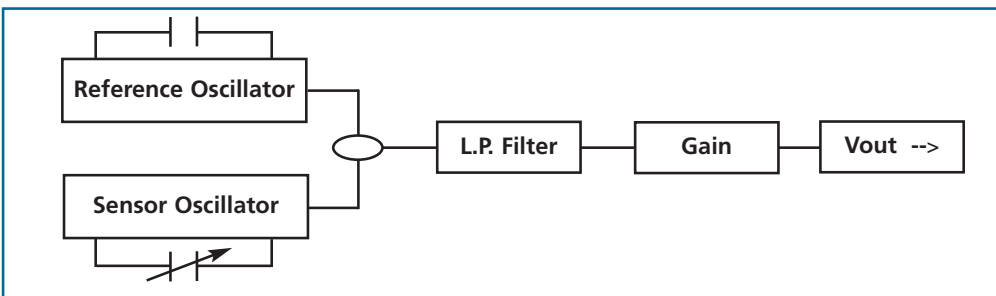

Suggested applications for HM1500

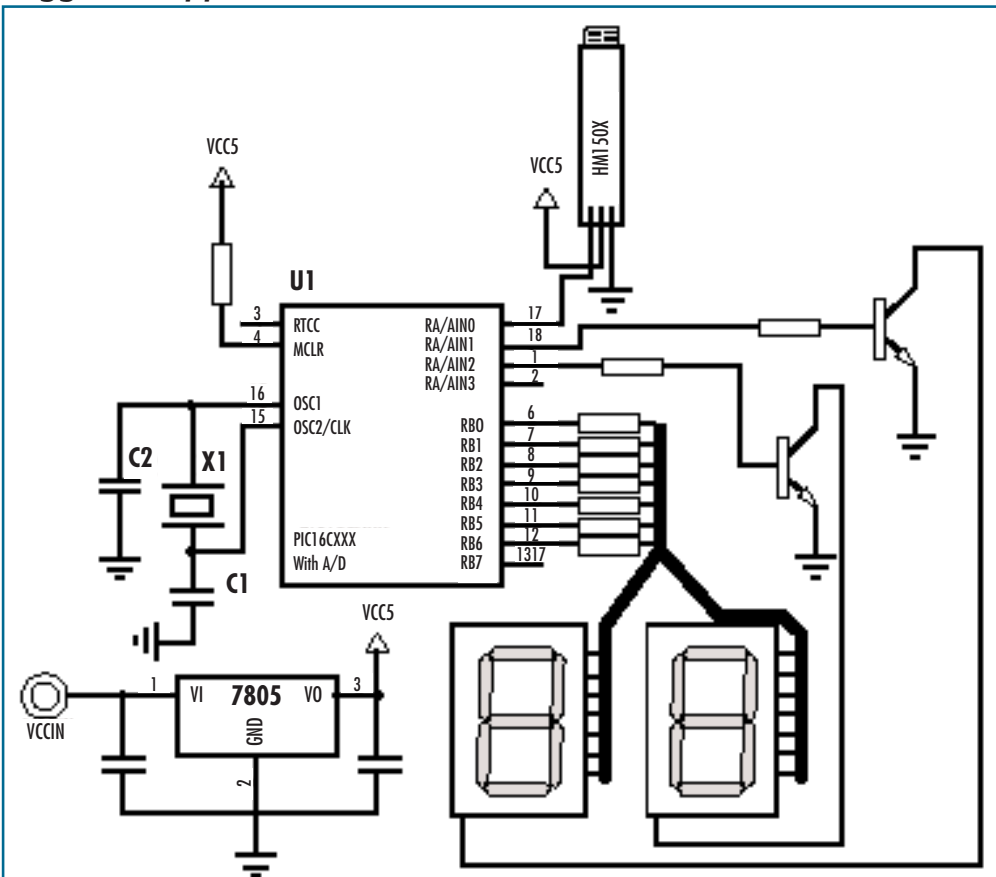

Steps of 1% RH are achievable by using 8-bit A/D. If more resolution is required a 10-bit A/D needs to be used and a third display will be added, giving steps of 0.2% RH

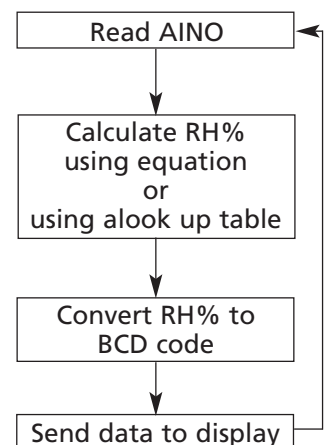

● RESISTANCE TO PHYSICAL AND CHEMICAL STRESSES

- HM1500 has passed through qualification processes of HUMIREL including vibration, shock, storage, high temperature and humidity, ESD.
- Additional tests under harsh chemical conditions demonstrate good operation in presence of salt atmosphere, SO₂ (0.5%), H₂S (0.5%), O₃, NO_x, NO, CO, CO₂, Softener, Soap, Toluene, acids (H₂SO₄, HNO₃, HCl), HMDS, Insecticide, Cigarette smoke, a non exhaustive list.
- HM1500 is not light sensitive.

● SPECIFIC PRECAUTIONS

- HM1500 is not protected against reversed polarity - Check carefully when connecting the device.
- If you wish to use HM1500 in a chemical atmosphere not listed above, consult us.

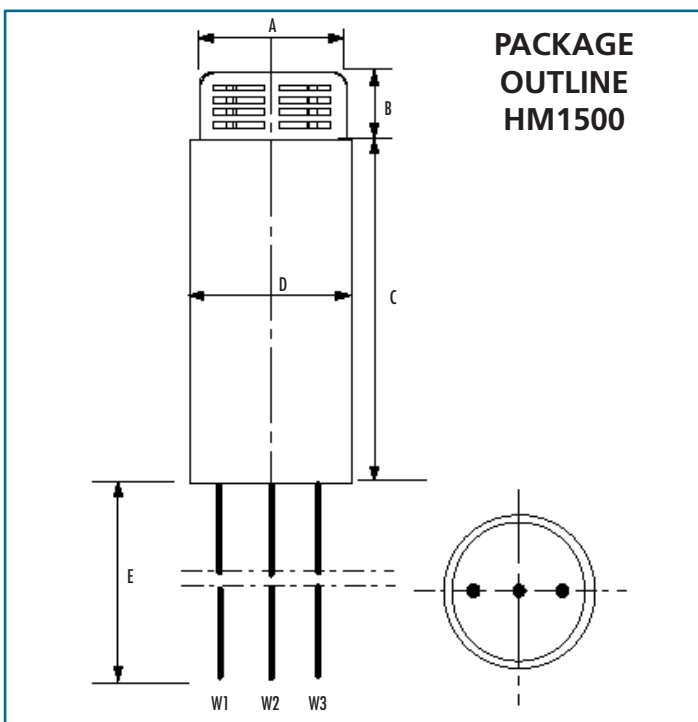

Dim	Min (mm)	Max (mm)
A	9.70	10.20
B	5.00	5.50
C	52	54
D	11.2	11.6
E*	200	250

* specific length available on request

Wire	Color	Function
W1	White	GROUND
W2	Blue	SUPPLY VOLTAGE
W3	Yellow	OUTPUT VOLTAGE

ORDERING INFORMATION (MULTIPLE PACKAGE QUANTITY OF 10 PIECES). HM1500 : HUMIDITY ANALOG VOLTAGE OUTPUT MODULE.

**SAMPLE KIT OF HM1500
IS AVAILABLE THROUGH
HUMIREL WEB SITE**

www.humirel.com

email : sales@humirel.com

The information in this sheet has been carefully reviewed and is believed to be accurate; however, no responsibility is assumed for inaccuracies. Furthermore, this information does not convey to the purchaser of such devices any license under the patent rights to the manufacturer. Humirel reserves the right to make changes without further notice to any product herein. Humirel makes no warranty, representation or guarantee regarding the suitability of its product for any particular purpose, nor does Humirel assume any liability arising out of the application or use of any product or circuit and specifically disclaims any and all liability, including without limitation consequential or incidental damages. « Typical » parameters can and do vary in different applications. All operating parameters, including « Typical » must be validated for each customer applications by customer's technical experts. Humirel does not convey any license under its patent rights nor the rights of others. Humirel products are not designed, intended, or authorized for use as components in systems intended for surgical implant into the body, or other application intended to support or sustain life, or for any application in which the failure of the Humirel product could create a situation where personal injury or death may occur. Should buyer purchase or use Humirel products for any such unintended or unauthorized application, Buyer shall indemnify and hold Humirel and its officers, employees, subsidiaries, affiliates and distributors harmless against all claims, costs, damages and expenses, and reasonable attorney fees arising out of, directly or indirectly, any claim of personal injury or death associated with such unintended or unauthorized use, even if such claim alleges that Humirel was negligent regarding the design or manufacture of the part. Humirel is a registered trade mark of Humirel.